

DRAWMER

M-Clock Plus



DMS-5

AES GRADE 1 MASTER CLOCK AND DUAL SAMPLE RATE CONVERTER

CONTENTS

Warranty	2
Safety Consideration	2
Radio Frequencies Statement	2
 <i>Chapter 1 - Introduction</i>	
Introduction	3
Installation	4
Audio Connection & Guide	4
 <i>Chapter 2 - Control Description</i>	
Multiple Sample Rate Converter	6
Master Clock Generator	7
 <i>Chapter 3 - General Information</i>	
If a fault develops	8
Contacting Drawmer	8
Specification	8
Block Diagram	9

COPYRIGHT

This manual is copyrighted © 2008 by Drawmer Electronics Ltd. With all rights reserved. Under copyright laws, no part of this publication may be reproduced, transmitted, stored in a retrieval system or translated into any language in any form by any means, mechanical, optical, electronic, recording, or otherwise, without the written permission of Drawmer Electronics Ltd.

ONE YEAR LIMITED WARRANTY

Drawmer Electronics Ltd., warrants the Drawmer DMS-5 M-Clock Plus, AES Grade 1 Master Clock and Dual Sample Rate Converter to conform substantially to the specifications of this manual for a period of one year from the original date of purchase when used in accordance with the specifications detailed in this manual. In the case of a valid warranty claim, your sole and exclusive remedy and Drawmer's entire liability under any theory of liability will be to, at Drawmer's discretion, repair or replace the product without charge, or, if not possible, to refund the purchase price to you. This warranty is not transferable. It applies only to the original purchaser of the product.

For warranty service please call your local Drawmer dealer. Alternatively call Drawmer Electronics Ltd. at +44 (0)1709 527574. Then ship the defective product, with transportation and insurance charges pre-paid, to Drawmer Electronics Ltd., Coleman Street, Parkgate, Rotherham, S62 6EL UK. Write the RA number in large letters in a prominent position on the shipping box. Enclose your name, address, telephone number, copy of the original sales invoice and a detailed description of the problem. Drawmer will not accept responsibility for loss or damage during transit.

This warranty is void if the product has been damaged by misuse, modification or unauthorised repair.

THIS WARRANTY IS IN LIEU OF ALL WARRANTIES, WHETHER ORAL OR WRITTEN, EXPRESSED, IMPLIED OR STATUTORY. DRAWMER MAKES NO OTHER WARRANTY EITHER EXPRESS OR IMPLIED, INCLUDING, WITHOUT LIMITATION, ANY IMPLIED WARRANTIES OF MERCHANTABILITY, FITNESS FOR A PARTICULAR PURPOSE, OR NON-INFRINGEMENT. PURCHASER'S SOLE AND EXCLUSIVE REMEDY UNDER THIS WARRANTY SHALL BE REPAIR OR REPLACEMENT AS SPECIFIED HEREIN.

IN NO EVENT WILL DRAWMER ELECTRONICS LTD. BE LIABLE FOR ANY DIRECT, INDIRECT, SPECIAL, INCIDENTAL OR CONSEQUENTIAL DAMAGES RESULTING FROM ANY DEFECT IN THE PRODUCT, INCLUDING LOST PROFITS, DAMAGE TO PROPERTY, AND, TO THE EXTENT PERMITTED BY LAW, DAMAGE FOR PERSONAL INJURY, EVEN IF DRAWMER HAS BEEN ADVISED OF THE POSSIBILITY OF SUCH DAMAGES.

Some states and specific countries do not allow the exclusion of implied warranties or limitations on how long an implied warranty may last, so the above limitations may not apply to you. This warranty gives you specific legal rights. You may have additional rights that vary from state to state, and country to country.

For the USA

FEDERAL COMMUNICATIONS COMMISSION RADIO FREQUENCY INTERFERENCE STATEMENT

This equipment has been tested and found to comply with the limits for a Class B digital device, pursuant to Part 15 of the FCC Rules. These limits are designed to provide reasonable protection against harmful interference in a residential installation. This equipment generates, uses and can radiate radio frequency energy and, if not installed and used in accordance with the instructions, may cause harmful interference to radio communications. However, there is no guarantee that interference will not occur in a particular installation. If this equipment does cause interference to radio or television reception, which can be determined by turning the equipment off and on, then the user is encouraged to try to correct the interference by one or more of the following measures:

- Re-orient or relocate the receiving antenna.
- Increase the separation between the equipment and the receiver.
- Connect the equipment into an outlet on a circuit different from that to which the receiver is connected.
- Consult the dealer or an experienced radio/TV technician for help.

Unauthorised changes or modification to this system can void the users' authority to operate this equipment. This equipment requires shielded interface cables in order to meet FCC class B limit.

For Canada

CLASS B NOTICE
This digital apparatus does not exceed the Class B limits for radio noise emissions set out in the Radio Interference Regulations of the Canadian Department of Communications.

CLASSE B AVIS
Cet appareil numérique ne dépasse pas les limites de la classe B au niveau des émissions de bruits radioélectriques fixés dans le Règlement des signaux parasites par le ministère Canadien des Communications.

DRAWMER M-Clock Plus

DMS-5

AES GRADE 1 MASTER CLOCK AND DUAL SAMPLE RATE CONVERTER

SAFETY CONSIDERATIONS

CAUTION - MAINS FUSE

TO REDUCE THE RISK OF FIRE
REPLACE THE MAINS FUSE ONLY WITH
A FUSE THAT **CONFORMS TO IEC127-2**.
250 VOLT WORKING, TIME DELAY TYPE
AND BODY SIZE OF 20mm x 5mm.
THE MAINS INPUT FUSE MUST BE
RATED AT T315mA.

CAUTION - MAINS CABLE

DO NOT ATTEMPT TO CHANGE
OR TAMPER WITH THE
SUPPLIED MAINS CABLE.

CAUTION - SERVICING

DO NOT PERFORM ANY SERVICING.
REFER ALL SERVICING TO QUALIFIED
SERVICE PERSONNEL.

WARNING

TO REDUCE THE RISK OF FIRE OR
ELECTRIC SHOCK DO NOT EXPOSE
THIS EQUIPMENT TO RAIN OR MOISTURE.



In the interests of product development, Drawmer reserve the right to modify or improve specifications of this product at any time, without prior notice.

DRAWMER M-Clock Plus DMS-5

AES GRADE 1 MASTER CLOCK AND DUAL SAMPLE RATE CONVERTER

INTRODUCTION

The M-Clock Plus is a high stability master clock generator offering clock rates from 44.1 to 192kHz, coupled to two sample rate converters, which allow material to be re-sampled and synchronised to the selected high precision clock.

In addition to the internal clocks, M-Clock Plus can sync to either external word clock or clocks from AES/EBU signals. Precision clock frequency measurement and display indicates the exact frequency of the selected clock, whether internal or external, to an accuracy of 2ppm.



Features:

- M-Clock Plus has an external word clock input and an AES11 input which retrieves the clock from an AES audio signal.
- Each sample rate converter has selectable AES, SPDIF or TOSLINK inputs, with simultaneous AES, SPDIF and TOSLINK outputs. This allows many possibilities for format conversion as well as sample rate conversion.
- Sample rate converter #2 has inputs on the front panel for easy access.
- User selectable word length of 16 or 24 bits with automatic dither generation - particularly valuable for 16 bit word lengths at low signal levels.
- 10 word clock outputs - 8 at the rear and 2 at the front for easy access.

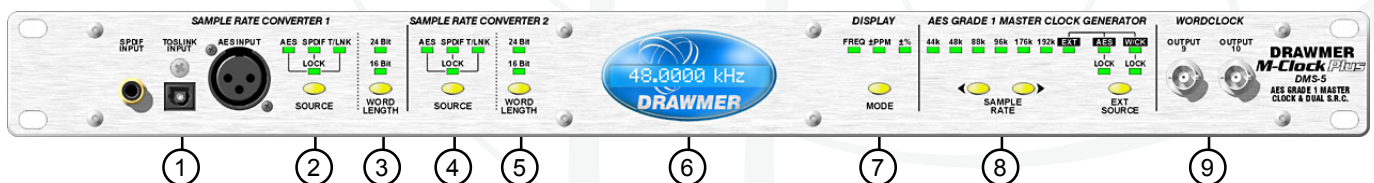

- | | | |
|------------------------------------------------------------------------------------------------------------------------------------------------------------------------------------------------------------------------------------------------------------------------------------------------------------------------------------------------------|---------------------------------------------------------------------------------------------------------------------------------------------------------------------------------------------------------------------------------------------------------------------------------------------------------------------------------------|----------------------------------------------------------------------------------------------------------------------------------------------------------------------------------------------------------------------------------------------------------------------------------------------------------------------|
| <p>① S.R.C.1 Inputs:
One each of <i>SPDIF</i>, <i>TOSLINK</i> or <i>AES</i> conveniently located for easy access.</p> <p>④ S.R.C.2 Source:
Switch to select one of the three the S.R.C.2 Input Sources (①). With lock led.</p> <p>⑦ Display Mode:
Switch to control the Mode of Display (⑥) from FREQ. +/-PPM or +/-%.</p> | <p>② S.R.C.1 Source:
Switch to select one of the three the S.R.C.1 Input Sources (①) With lock led.</p> <p>⑤ S.R.C.2 Word Length:
Switch to select S.R.C.1 Word Length of 16 or 24 Bit.</p> <p>⑧ Master Clock Generator:
Output sample rate selector with switch for EXT source also (⑬).</p> | <p>③ S.R.C.1 Word Length:
Switch to select S.R.C.1 Word Length of 16 or 24 Bit.</p> <p>⑥ Display:
Blue/White liquid crystal display with three switchable modes of operation.</p> <p>⑨ Wordclock Outputs 9/10:
Two extra wordclock outputs conveniently placed for easy access.</p> |
|------------------------------------------------------------------------------------------------------------------------------------------------------------------------------------------------------------------------------------------------------------------------------------------------------------------------------------------------------|---------------------------------------------------------------------------------------------------------------------------------------------------------------------------------------------------------------------------------------------------------------------------------------------------------------------------------------|----------------------------------------------------------------------------------------------------------------------------------------------------------------------------------------------------------------------------------------------------------------------------------------------------------------------|

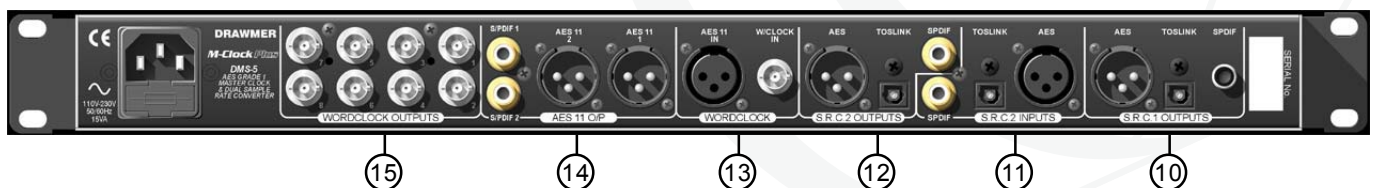

- | | | |
|--------------------------------------------------------------------------------------------------------------------------------------------------------------------------------------------------------------------------------------|-------------------------------------------------------------------------------------------------------------------------------------------------------------------------------------------------------------------------------------------|-------------------------------------------------------------------------------------------------------------------------------------------------------------------------------------------------------------|
| <p>⑩ S.R.C.1 Outputs:
One each of <i>SPDIF</i>, <i>TOSLINK</i> or <i>AES</i> symultaneous outputs.</p> <p>⑬ Wordclock Inputs:
Inputs in both standard wordclock (BNC) and AES 11 (XLR) upto 192kHz.</p> | <p>⑪ S.R.C.2 Inputs:
One each of <i>SPDIF</i>, <i>TOSLINK</i> or <i>AES</i> selected via (④)</p> <p>⑭ 4x AES 11 XLR & SPDIF Outputs:
outputs to the AES 11 standard (Also called DARS, Blank Frame).</p> | <p>⑫ S.R.C.2 Outputs:
One each of <i>SPDIF</i>, <i>TOSLINK</i> or <i>AES</i> symultaneous outputs.</p> <p>⑮ 8x BMC Clock Outputs:
Buffered BNC wordclock outputs with 33 Ohms impedance.</p> |
|--------------------------------------------------------------------------------------------------------------------------------------------------------------------------------------------------------------------------------------|-------------------------------------------------------------------------------------------------------------------------------------------------------------------------------------------------------------------------------------------|-------------------------------------------------------------------------------------------------------------------------------------------------------------------------------------------------------------|

INSTALLATION

The DMS-5 is designed for standard 19" rack mounting and occupies 1U of rack space. Avoid mounting the unit directly above power amplifiers or power supplies that radiate significant amounts of heat.

If the unit is to be used in a mobile situation, it is strongly recommended that the rear of the unit is supported in the carrying rack to avoid bending the front panel rack mounting 'ears'. Use fibre or plastic washers to prevent the front panel becoming marked by the mounting bolts.

The unit will be supplied with a power cable suitable for domestic power outlets in your country. For your own safety it is important that you use this cable. The unit should always be connected to the mains supply earth using this cable.

Powered by a universal switch mode power supply, the DMS-5 M-Clock Plus operates from mains voltages between 85 - 250v, eliminating the need to make any changes when touring and allowing the unit to remain fully operational during large fluctuations in the mains power supply.

AUDIO CONNECTIONS

AES11

Is via an XLR connector designed to be used with standard balanced microphone cable (20 metres maximum), wired pin 1 screen, pin 2 and 3 balanced data, and the XLR shell connected to the chassis. Having many short cables joined together is not advisable as each connector can cause undesirable signal reflections.

The output socket fully conforms to the EMC standards; if the unit is to be used where it may be exposed to high levels of disturbance, such as found close to a TV or radio transmitter, it is suggested that the screen of the data cable be connected to the chassis connection on the XLR type connector rather than to pin 1.

If ground loop problems are encountered, never disconnect the mains ground, but instead, try disconnecting the signal screen on one end of each cable connecting the outputs.

S/PDIF

Is via a high quality RCA type phono jack where the data conforms to the Sony/J Phillips/J Digital InterFace format. Because this connector only provides an unbalanced termination, the recommended maximum length for this cable is 3 metres, even with very high quality cable.

TOSLINK (or EIAJ)

The real benefit of TOSlink is that it is not susceptible to electromagnetic noise, however, it is highly recommended that a very good quality cable is used as the plastic conductors used in cheap cables can damage data. Additionally performance is compromised over long lengths of cable, as the signal strength weakens due to impurities in the conductive material, therefore lengths of no longer than five metres is recommended unless using a signal booster.

Though the connectors are the same TOSLink and ADAT Optical are not compatible with each other.

Word Clock

Use only good quality 75Ω digital or video coax (not aerial downlead) cable for the word-clock signals, terminated with the correct type of 75Ω BNC connectors - inferior cables will introduce jitter and will completely undermine the performance benefits which might be achieved by using a master clock in the first place!

SIMPLE WORDCLOCK DISTRIBUTION SETUP

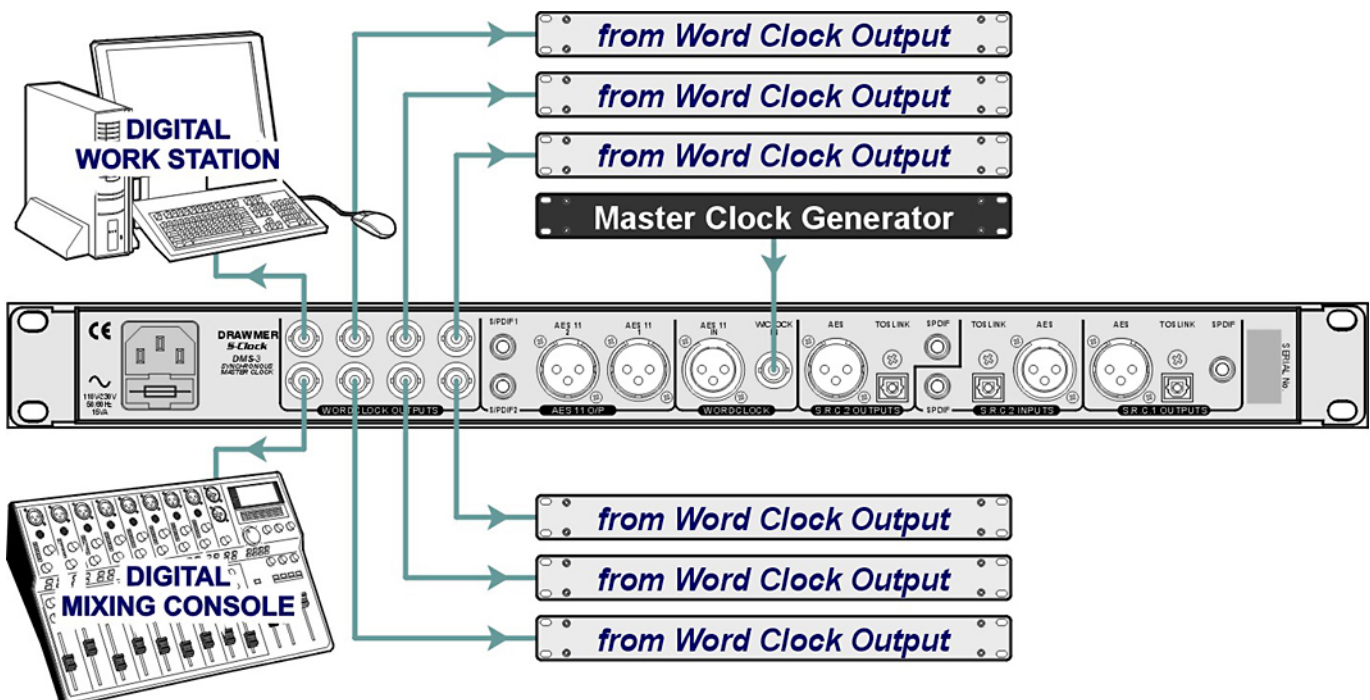

TYPICAL CONNECTION GUIDE (M-Clock Plus Generates Clock).

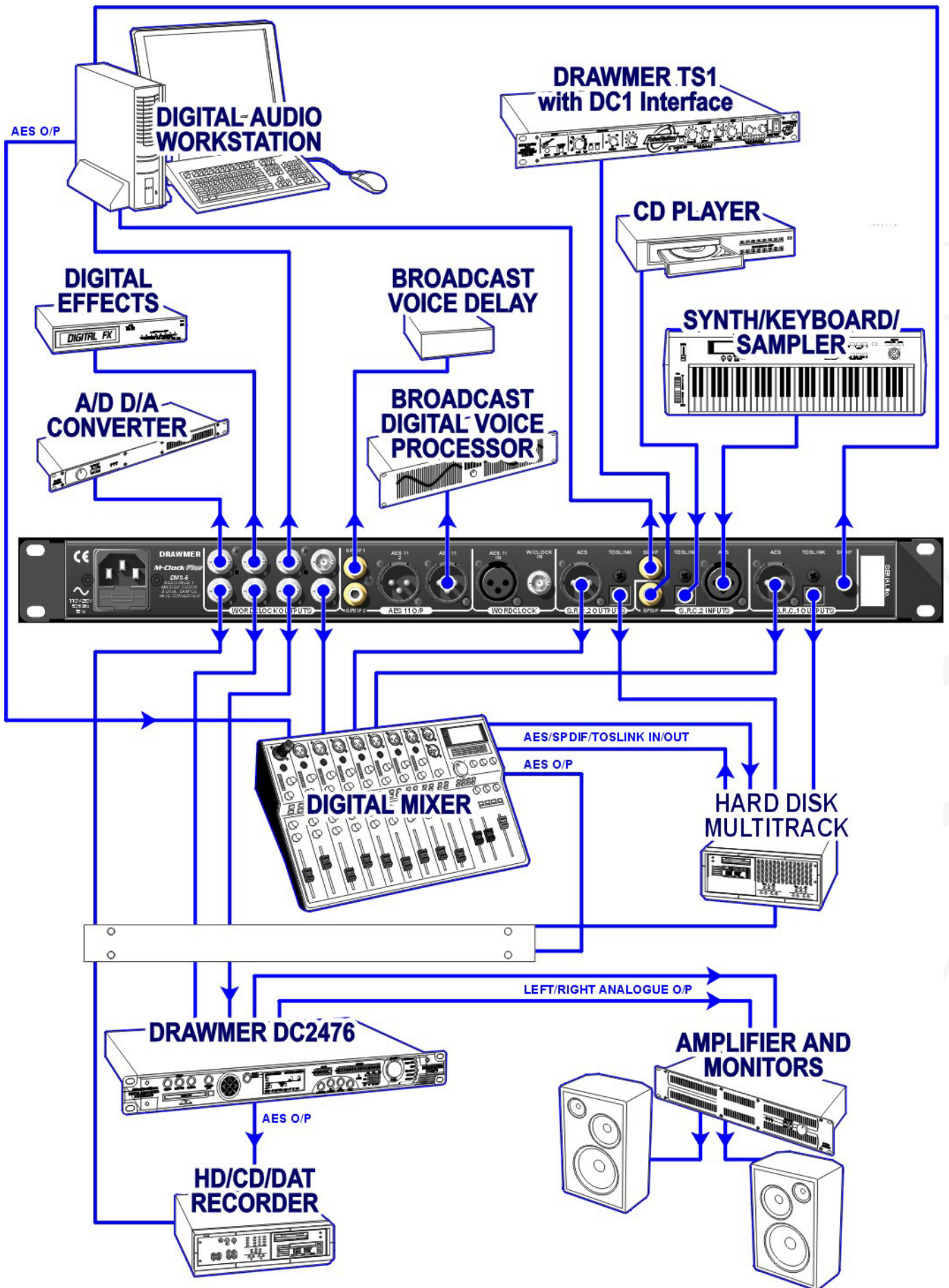

CONTROL DESCRIPTION



The Drawner M-Clock Plus supplies ten word clock outputs, as well as two simultaneous outputs of S/PDIF and AES/EBU allowing you to synchronize your digital workstation, A/D converter, digital mixer and a host of other digital audio equipment through one stable and very accurate unit. Certain equipment in the studio may not have word clock inputs which has in the past caused synchronisation problems, using the DMS-5 M-CLOCK Plus these digital audio sources may be synced to the same ultra low jitter AES

grade 1 stability master clock generator as the equipment using the word clock outputs from the DMS-5.

In addition, if any equipment in the studio suffers jitter at its output these sample rate converters may be used to de-jitter and re-clock the signals before further transmission. The M-clock Plus provides a wide range of sample rates from 44.1k upto 192k, all set using the front panel switching. Each sample rate converter input is fed simultaneously to AES/EBU, SPDIF and TOSLINK outputs solving any connectivity problems and allowing signal distribution.

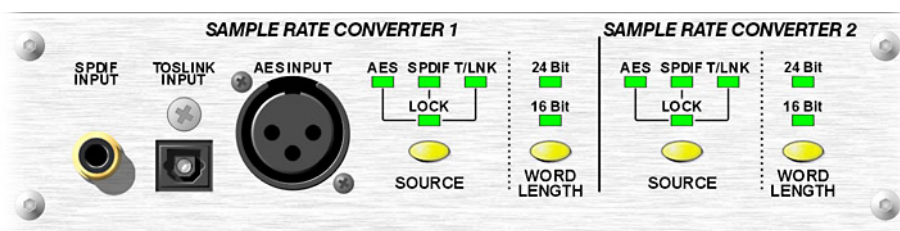

Sample Rate Converter 1 SOURCE

Three inputs are conveniently located on the front panel for easy access - **SPDIF, TOSLINK** and **AES**. Toggle through the "Source" switch to select the desired input. A lock LED is provided - when lit a strong signal is being received by that input source and the M-Clock Plus is "locked on". If the LED is off the input source may be missing, weak or unstable - in this case the source of the signal should be located and improved.

WORD LENGTH A switch provides either 16 or 24 Bit operation.

Sample Rate Converter 2 SOURCE

Toggle through the "Source" switch to select the desired input on the S.R.C.2 outputs on the rear panel. A lock LED is provided on the front - when lit a strong signal is being received by that input source and the M-Clock Plus is "locked on". If the LED is off the input source may be missing, weak or unstable - in this case the source of the signal should be located and improved.



WORD LENGTH As above.



DISPLAY

A Blue/White LCD display with four switchable modes of operation: When reading from its own internal clock the M-Clock Plus will display a sample rate of 44.1kHz. , when reading from an **EXT**ernal source it displays either **FREQ, ±PPM** or **±%** depending on the **mode** set. The mode that is selected during power down is saved for the next session. The display accuracy is 2ppm at all sample rates up to 192kHz, or 0.1Hz increments @ 48kHz sample rate.

MODE

With the sample rate set to **EXT** a switch controls the **mode** of display enabling you to read the incoming sample rate in your preferred manner. Pressing the switch toggles through the three modes of **FREQ**, **±PPM** and **±%**, with led indication.

FREQ



Displays the actual frequency to four decimal places upto 192kHz.

±PPM



Displays the nominal sample rate with +/- ppm (part per million) error indication for 32, 44.1, 48, 88.2, 96 & 192KHz.

±%



Displays the nominal sample rate with percentage pull up/down indication for 32, 44.1, 48, 88.2, 88.2, 96 & 192KHz

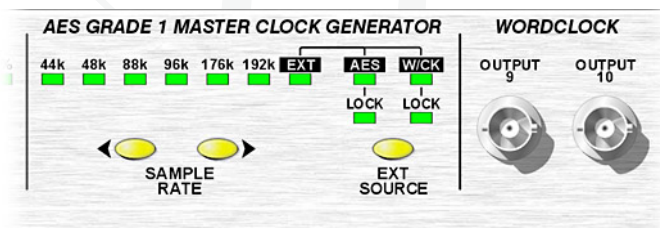

MASTER CLOCK GENERATOR

SAMPLE RATE

The outgoing sample rate for all outputs of the DMS-5 can be set using the two sample rate switches - the left moving down rate and the right moving up, with a corresponding LED being lit to show the current sample rate. The DSM-5 generates six Ultra Low Jitter sample rates - 44.1k, 48k, 88.2k, 96k, 176.4k and 192k, all stable to <1ppm, and in addition can also operate at the sample rate generated by an external source.

EXT SOURCE

With the Sample Rate set to EXT the EXT SOURCE switch toggles between either AES or Wordclock (as located on the rear panel). As with the "Source" section a lock LED is provided on the front and operates when the EXT clock signal is strong.

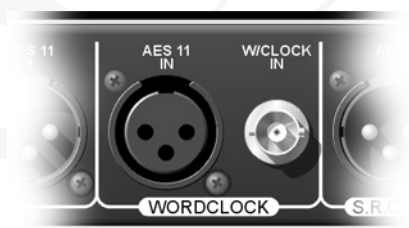

M-CLOCK Plus DMS-5 GENERAL INFORMATION

IF A FAULT DEVELOPS

For warranty service please call Drawmer Electronics Ltd. or their nearest authorised service facility, giving full details of the difficulty.

A list of all main dealers can be found on the Drawmer webpages.

On receipt of this information, service or shipping instructions will be forwarded to you.

No equipment should be returned under the warranty without prior consent from Drawmer or their authorised representative.

For service claims under the warranty agreement a service Returns Authorisation (RA) number will be issued.

Write this RA number in large letters in a prominent position on the shipping box. Enclose your name, address, telephone number, copy of the original sales invoice and a detailed description of the problem.

Authorised returns should be prepaid and must be insured.

All Drawmer products are packaged in specially designed containers for protection. If the unit is to be returned, the original container must be used. If this container is not available, then the equipment should be packaged in substantial shock-proof material, capable of withstanding the handling for the transit.

CONTACTING DRAWMER

Drawmer Electronics Ltd., will be pleased to answer all application questions to enhance your usage of this equipment. Please address correspondence to:

Drawmer (Technical Help line)
 Coleman Street
 Parkgate
 Rotherham
 S62 6EL
 UK

Alternatively contact us by E-mail on :

tech@drawmer.com

Further information on all Drawmer dealers, Authorised service departments and other contact information can be obtained from our web pages on:

<http://www.drawmer.com>

SPECIFICATION

Internal Clock Generator

2 x Temperature Compensated Xtal Oscillators (TCXOs)

AES11 GRADE 1 Stability, Tolerance +/-1ppm (0-60 Celcius), <<+/-1ppm (15-30 Celcius)

Phase noise -130 dBc/Hz @ 1kHz

@ 24.5760 MHz to give Fs 48, 96 & 192 kHz

@ 22.5792 MHz to give Fs 44.1, 88.2 & 176.4kHz

Word Clock Outputs

Output impedence 33 ohms

All outputs selectable between 44.1, 48, 88.2, 96, 176.4 and 192 kHz

AES 11 Outputs

2 x Neutrik XLR 110 ohm source @ 44.1, 48, 88.2, 96, 176,192kHz

2 x Gold Plated Phono 75 ohm source @ 44.1, 48, 88.2, 96, 176,192kHz

Sample Rate Conversion

2 x Stereo Sample Rate Converters: full up/down conversion from 44.1kHz to 192kHz

2 x Neutrik XLR AES/EBU inputs

2 x Phono SPDIF inputs

2 x TOSlink inputs

All outputs simultaneous on 2 x AES/EBU XLR, 2 x SPDIF Phono, 2 x TOSLINK

THD+Noise > 130 dBFS

Display

Blue/white LCD display with three switchable modes of operation with mode led indicators for each:

frequency actual frequency up to >192KHz

+/- ppm nominal sample rate with +/- ppm error indication for 32,44.1,48,88.2, 96 & 192KHz

+/-% Nominal sample rate with percent pull up/down indication for 32,44.1,48,88.2, 96 & 192KHz

Accuracy 2ppm at all sample rates up to 192KHz
 0.1 Hz increments @ 48KHz sample rate

General

Power Supply: Internal, Universal Input, 15 W

Fuse Rating T315mA for All voltages.
 CONFORMING TO: IEC127-2

Fuse Type 20mm x 5mm, Class 3 Slow - Blow
 250Volt working

Dimensions: 1u, 19" Rack Mount,
 482mm(W) x 44mm(H) x 145mm(D)

Weight 2.025 kg

BLOCK DIAGRAM

